

Contents:

Lock
Assembly
Instructions
Warranty
Card

Tools Required:

Phillips Head Screw Driver

Tech Support:

Call 1-800-342-5911

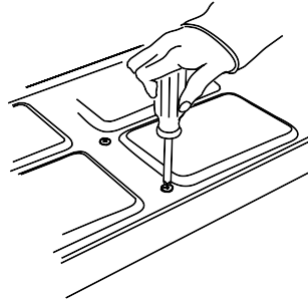

- 1.** Unscrew the 8 access panel screws and remove panel

Note: Bedliner panel may have to be removed.

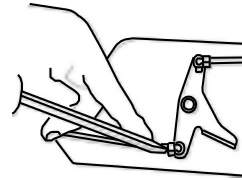

- 2.** Carefully unclip the plastic rod retainers off using a screw driver and remove rods from the scissor.

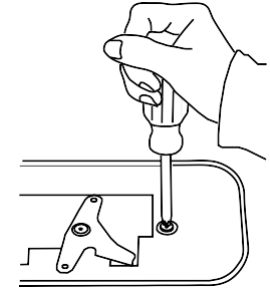

- 3.** Unscrew the two handle mounting screws and remove handle.

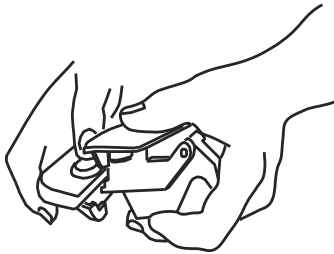

- 4.** Join the handle and the POP&LOCK together like a tongue and groove.

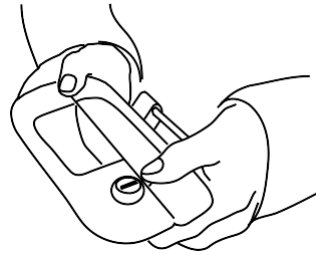

- 5.** Push the handle firmly down onto the POP&LOCK until they fit together to form a tight assembly.

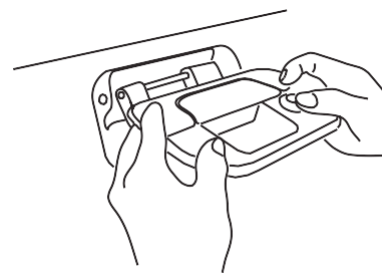

- 6.** Insert the handle and POP&LOCK assembly into the tailgate.

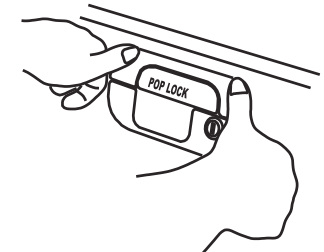

- 7.** Push the assembly down to align it with the mounting holes. Reassemble all components in the reverse order.

LIMITED WARRANTY TERMS AND CONDITIONS

- (1) **Installation.** Pop & Lock™, LLC (and Pop & Lock™ Corporation) is not responsible for installing the Pop & Lock™ or for the harm suffered by any person as a result installing it.
- (2) **Warranties.**
- Customer acknowledges that it is unreasonable to believe that any device whatever will prevent a theft in the case of every attempt and that the most that can be expected from a so-called anti-theft or security device is that it will deter many thieves.
 - POP & LOCK™ LLC. (and Pop & Lock™ Corporation) MAKES, AND CUSTOMER RECEIVES, NO WARRANTY, EXPRESSED OR IMPLIED, EXCEPT THE WARRANTIES OF TITLE TO THE POP & LOCK™ AND THEIR MERCHANTABILITY, PARTICULARLY NO WARRANTY OF FITNESS FOR A PARTICULAR USE OR PURPOSE OR AGAINST INFRINGEMENT.**
 - As Customer's only remedy, Pop & Lock™, LLC (and Pop & Lock™ Corporation) will repair or replace, at its option and without charge, any lock that is defective in material or workmanship when received by Customer and is returned to Pop & Lock™ LLC (and Pop & Lock™ Corporation), FOB Pop & Lock™ Corporation's offices, within one (1) year after it's receipt by the Customer. Pop & Lock LLC will ship all replacement, or repaired, Locks to Customer, FOB Pop & Lock™'s shipping point.
 - Factory support is only available for Pop & Lock™ products purchased as new through an Authorized Pop & Lock™ dealer.
- Please Note:** *Pop & Lock™ Products purchased on auctions sites such as Craigslist etc. will not be covered under factory warranty. Products purchased from an authorized dealer as "new" on websites such as Amazon and Ebay must follow their website warranty policy, process and procedures. Pop & Lock™ Products sold as "used", "refurbished", "open box" etc., cannot be verified by Pop & Lock™, LLC (and Pop & Lock™ Corporation), and as such, Pop & Lock, LLC (and Pop & Lock™ Corporation) is unable to warranty such purchases. Pop & Lock, LLC advises using extreme caution when buying through auction sites as you'll be doing so at your own risk.*
- (2) **No Liability.** Pop & Lock™ Corporation is not liable for any loss or damage claimed by Customer or any third person to have been suffered or incurred as a result or, or related to, the Locks purchased under this Agreement, regardless of the circumstances or form of action, except any bodily injury or death for which Pop & Lock™ is liable under products-liability law. Without limiting the generality of the foregoing, in no event will Pop & Lock™ LLC be liable to Customer for any indirect, special, or consequential damages, regardless of the circumstances or the cause of action, particularly not for the value of a vehicle, or any other money damages in the event that a tailgate is stolen either notwithstanding the use of a Pop & Lock™ or when it has been returned for repair or replacement.

END OF TERMS AND CONDITIONS

POP & LOCK LLC 1271 CONTRACT DRIVE GREEN BAY, WI USA 54304

Additional Install Instructions and answers to technical questions can be found on our website at www.popandlock.net or by calling
Technical Support 1-800-342-5911 option 1
Monday – Friday 8:30am to 4:30pm CST

Pop and Lock's limited warranty expires one (1) year after date of purchase.

Proof of purchase is required for warranty claims. Please submit a scanned copy or electronic image/photo of your receipt through any of the following methods:

- E-mail: technicalsupport@popandlock.net
- Fax: 855-491-5911
- Mail: 1271 Contract Ave, Green Bay, Wisconsin (USA) 54304

Please be sure to include:

- Name, address and phone number
- Model and year of truck
- Model/Part number of the lock
- Brief description of the problem

